

9 S 1310 TO ZF-Ecomid (Truck)

Synchromesh gearbox for mid-range trucks

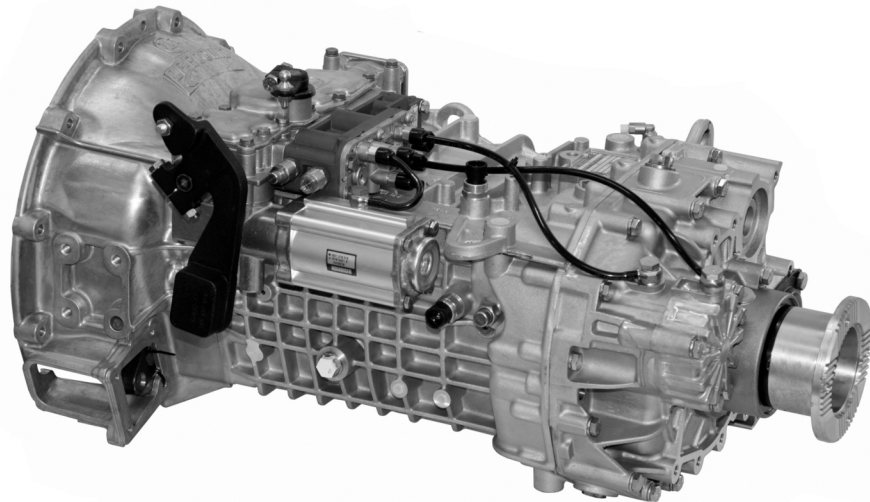

- 9 S 1310 TO - Basic transmission
- 9 S 1311 TO - Transmission with Intarder
- 9 S 1315 TO - Transmission with clutch-dependent PTO

Transmission type	9 S 1310 TO
Input torque	max. 1300 Nm
Weight without auxiliaries	≈ 190 kg*
Oil capacity for initial filling	≈ 8.9 dm ³
Oil grade	as specified in ZF List of Lubricants TE-ML 02
Clutch bell housing	SAE1 integrated / SAE2 optional
Additional weight for ZF-Intarder	≈ 71 kg
Additional oil quantity for ZF-Intarder	≈ 15 dm ³

incl. bell housing

Standard ratios in gears

Crawler	1	2	3	4	5	6	7	8	R
9.48	6.58	4.68	3.48	2.62	1.89	1.35	1.00	0.75	8.97

→ see also Data Sheet for Intarder: IT_9S1110_1310_EN

9 S 1310 TO

Installation dimensions

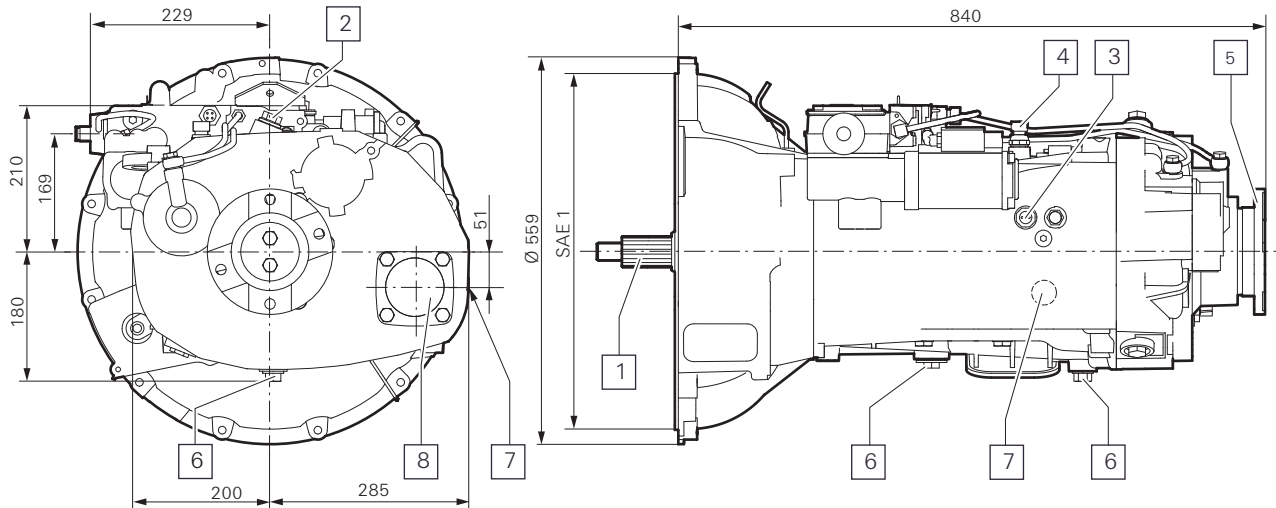

- | | |
|-------------------------------------|--------------------------------|
| 1 Input | 5 Output |
| 2 "Neutral" signal transmitter | 6 Oil drain |
| 3 "Range change" signal transmitter | 7 Oil fill and oil level check |
| 4 "Reverse gear" signal transmitter | 8 Connection for PTO |

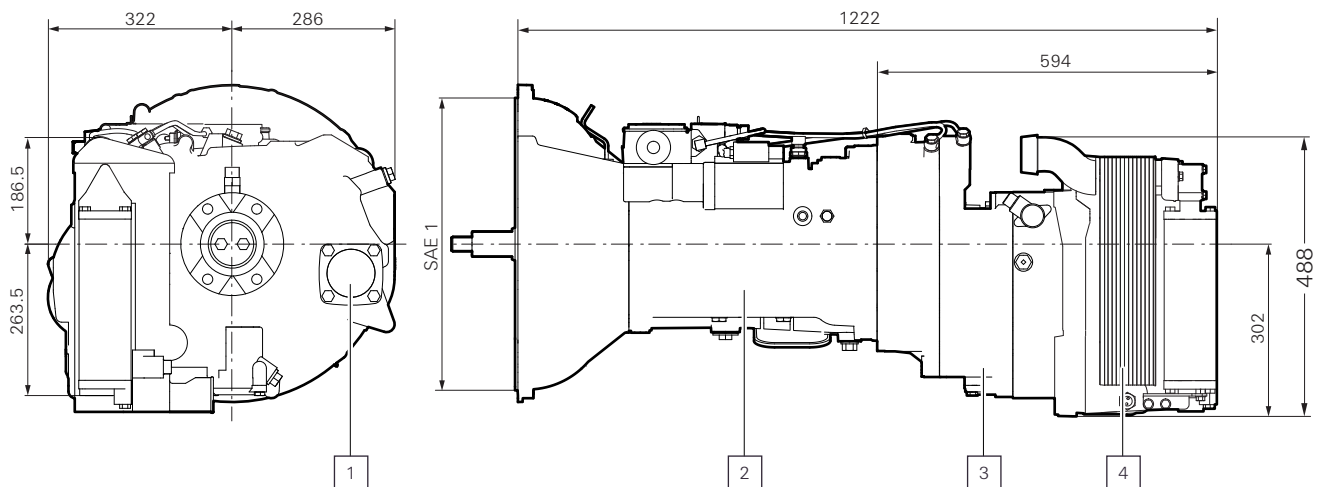

- | | |
|--------------------------|----------------------------|
| 1 Connection for PTO | 3 ZF-Intarder unit |
| 2 ZF-Ecomid transmission | 4 Oil/water heat exchanger |