

12 AS 2130 TD ZF-ASTronic (Truck)

Automatic transmission system for heavy trucks

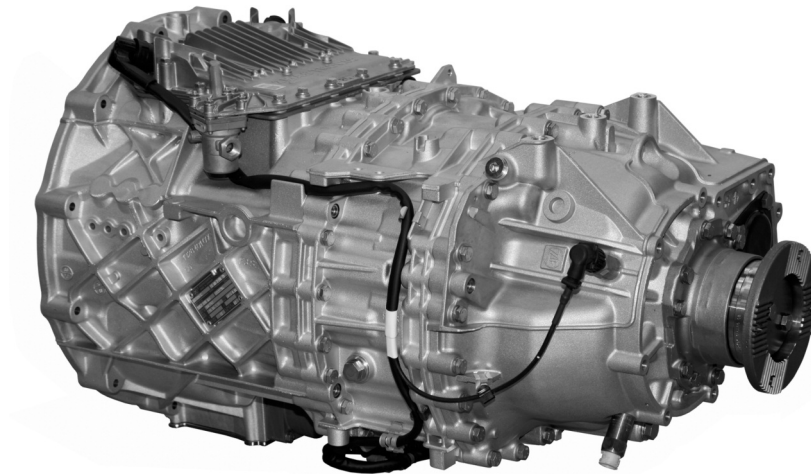

- 12 AS 2130 TD - Basic transmission
- 12 AS 2131 TD - Transmission with Intarder
- 12 AS 2135 TD - Transmission with clutch-dependent PTO

Transmission type	12 AS 2130 TD
Input torque	max. 2100 Nm
Weight* without auxiliaries	≈ 242 kg
Oil capacity for initial filling	≈ 12 dm ³
Oil grade	as specified in ZF List of Lubricants TE-ML 02
Clutch bell housing SAE 1	integrated
Additional weight for ZF-Intarder	≈ 70 kg
Additional oil quantity for ZF-Intarder	≈ 10 dm ³

*without oil fill, clutch and clutch release components

Standard ratios in gear

1	2	3	4	5	6	7	8	9	10	11	12	R1	R2
15.86	12.33	9.57	7.44	5.87	4.57	3.47	2.70	2.10	1.63	1.29	1.00	14.68	11.41

→ see also Data Sheet for Intarder: IT_AS_Tronic_Truck_EN

12 AS 2130 TD

Installation dimensions

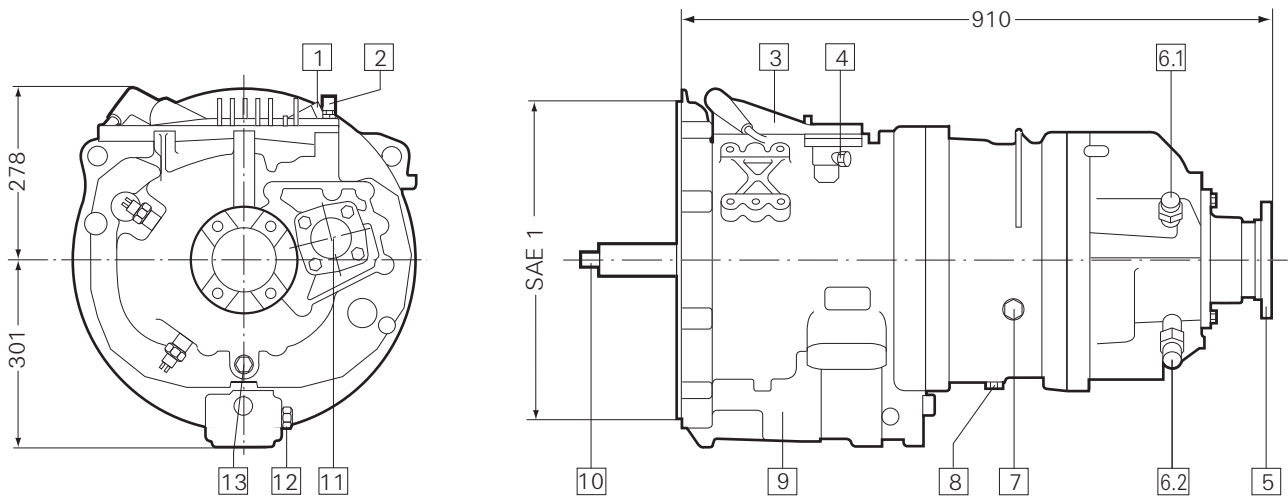

- | | |
|--------------------------------------|--|
| 1 Electrical connection | 7 Oil fill and oil level check |
| 2 Breather | 8 Oil drain |
| 3 Gearshift module | 9 Clutch module |
| 4 Compressed air connection | 10 Input |
| 5 Output | 11 Connection point for clutch-dependent PTO |
| 6.1 Speedo sensor, transmission side | 12 Compressed air connection |
| 6.2 Speedo sensor, vehicle side | 13 Oil drain |

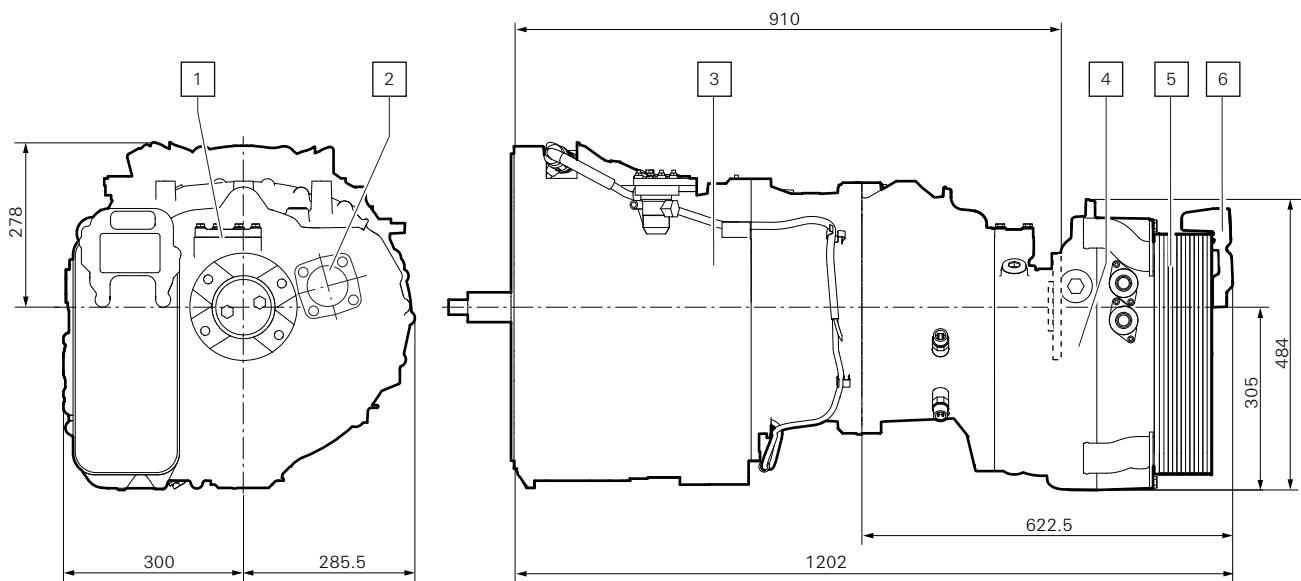

- | | |
|-------------------------------------|----------------------------|
| 1 Option to fit steering pump drive | 4 ZF-Intarder unit |
| 2 Connection for PTO | 5 Oil/water heat exchanger |
| 3 ZF-AS Tronic transmission | |