

# 12 AS 2740 TO ZF-ASTronic (Truck)

Automatic transmission system for heavy trucks

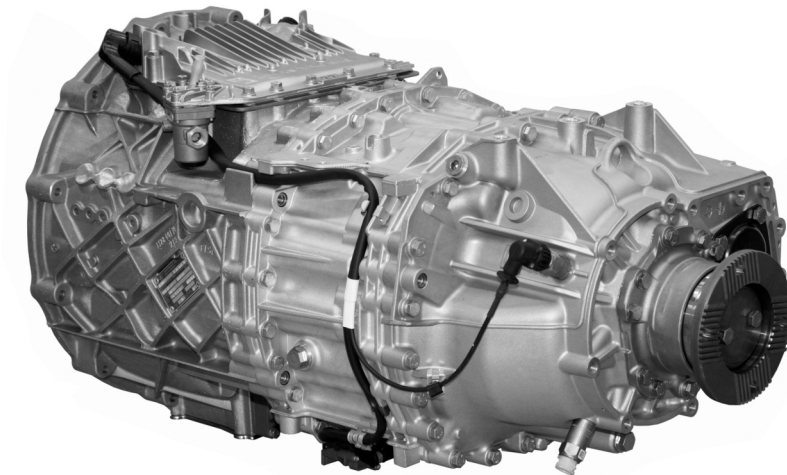

- 12 AS 2740 TO - Basic transmission
- 12 AS 2741 TO - Transmission with Intarder
- 12 AS 2745 TO - Transmission with clutch-dependent PTO

<b>Transmission type</b>	<b>12 AS 2740 TO</b>
<b>Input torque</b>	max. 2700 Nm
<b>Weight*</b> without auxiliaries	≈ 252 kg
<b>Oil capacity</b> for initial filling	≈ 13 dm <sup>3</sup>
<b>Oil grade</b>	as specified in ZF List of Lubricants TE-ML 02
<b>Clutch bell housing SAE 1</b>	integrated
<b>Additional weight for ZF-Intarder</b>	≈ 70 kg
<b>Additional oil quantity for ZF-Intarder</b>	≈ 10 dm <sup>3</sup>

\*without oil fill, clutch and clutch release components

### Standard ratios in gear

1	2	3	4	5	6	7	8	9	10	11	12	R1	R2
12.29	9.59	7.41	5.78	4.57	3.56	2.69	2.10	1.62	1.27	1.00	0.78	11.38	8.88

→ see also Data Sheet for Intarder: IT\_AS\_Tronic\_Truck\_EN

# 12 AS 2740 TO

## Installation dimensions

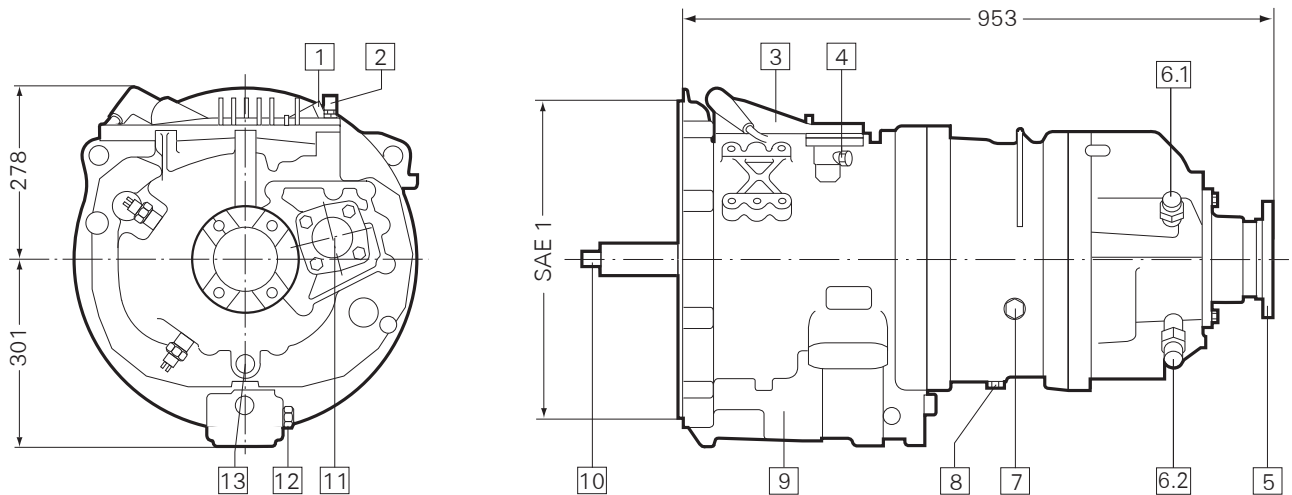

- |   |   |
|---|---|
| <b>1</b> Electrical connection              | <b>7</b> Oil fill and oil level check               |
| <b>2</b> Breather                           | <b>8</b> Oil drain                                  |
| <b>3</b> Gearshift module                   | <b>9</b> Clutch module                              |
| <b>4</b> Compressed air connection          | <b>10</b> Input                                     |
| <b>5</b> Output                             | <b>11</b> Connection point for clutch-dependent PTO |
| <b>6.1</b> Speedo sensor, transmission side | <b>12</b> Compressed air connection                 |
| <b>6.2</b> Speedo sensor, vehicle side      | <b>13</b> Oil drain                                 |

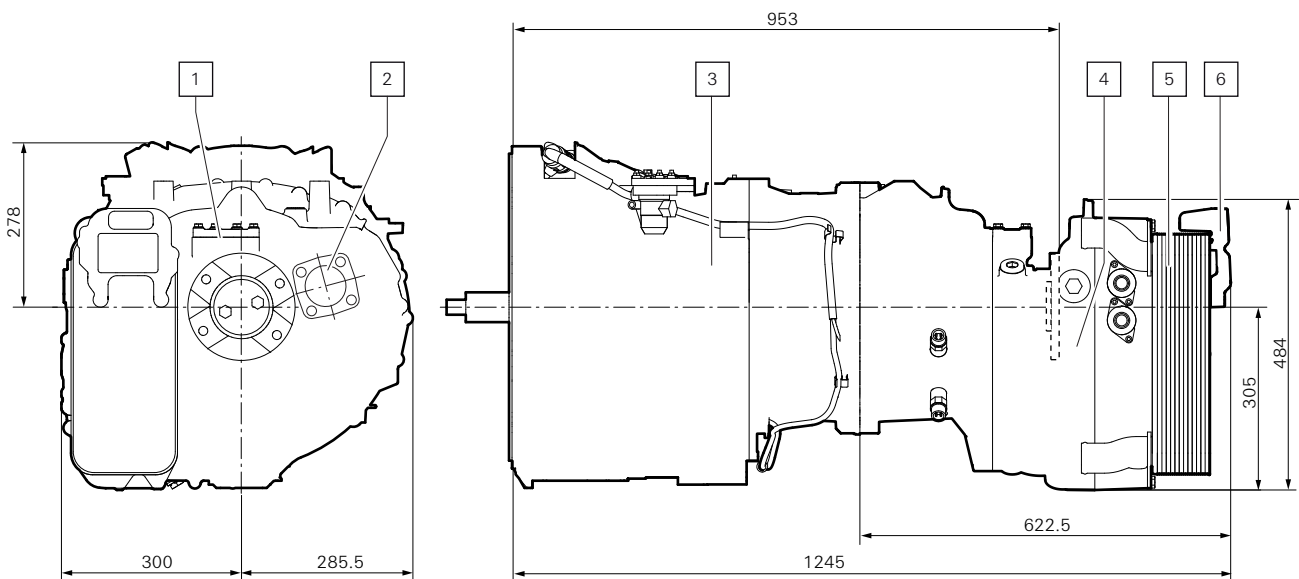

- |  |                                   |
|--|-----------------------------------|
| <b>1</b> Option to fit steering pump drive | <b>4</b> ZF-Intarder unit         |
| <b>2</b> Connection for PTO                | <b>5</b> Oil/water heat exchanger |
| <b>3</b> ZF-AS Tronic transmission         |                                   |